

# SafeZone Series SZ-412-S Single Spring Stand

The **SafeZone Series** SZ-412-S is the single spring-loaded version of our popular SZ-412. The single coil spring adds additional weight and redundancy to compensate for increased wind loads. The SZ-412-S is primarily used along the sides of state highways and interstates where wind loads are greater and more frequent.



## Compact and Lightweight

**SafeZone Series** Sign Stands are lightweight and require a minimum of space in your vehicles.

They are easy to carry for setup and deployment of your Roll-Up signs.



## Stand Carrying Bags

All **SafeZone Series** Stand Storage Bags are made of a heavy-duty fabric to help protect your stand when stored. The bags are mildew and rot resistant and are designed to prolong the life of your stand.

*The SZ-412-S is ideal for Utility Companies, Mowing Crews, Road Contractors & Underground Boring Companies using roll-up reflective and mesh signs.*

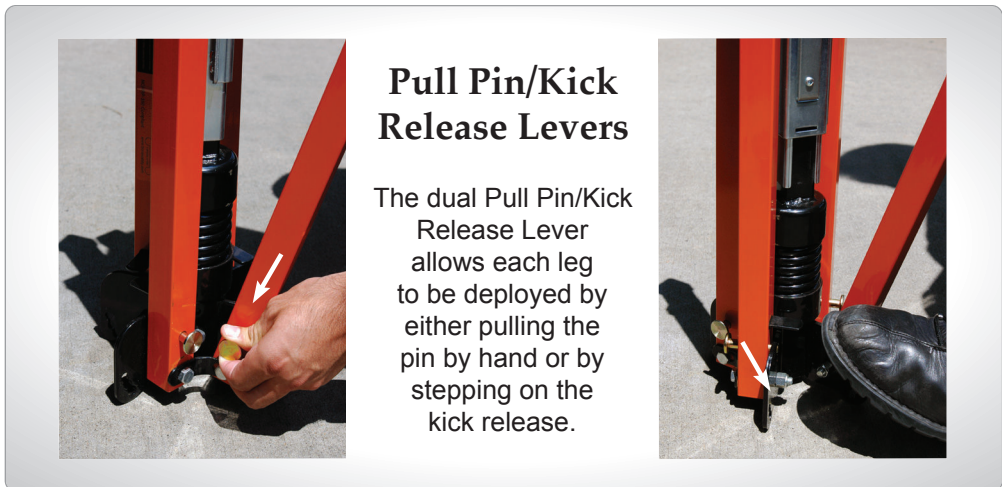
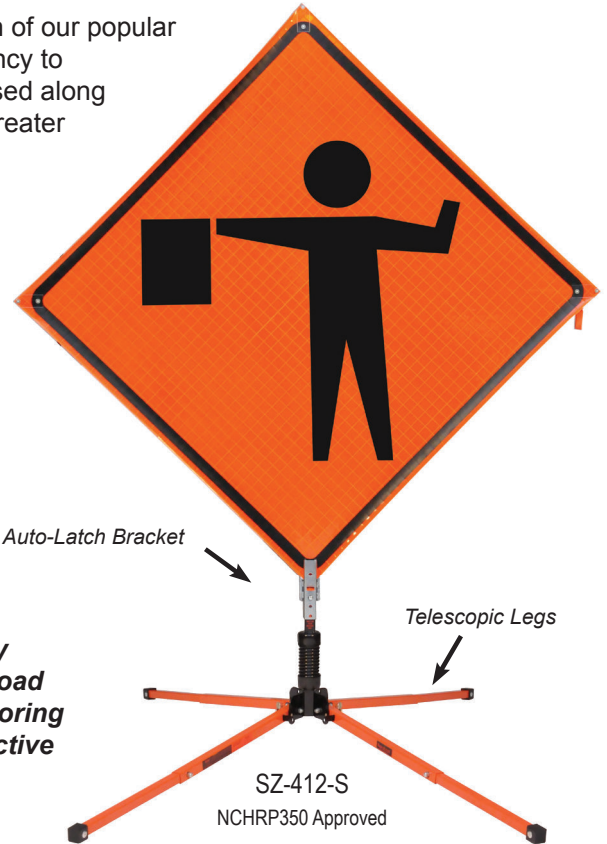

## Pull Pin/Kick Release Levers

The dual Pull Pin/Kick Release Lever allows each leg to be deployed by either pulling the pin by hand or by stepping on the kick release.

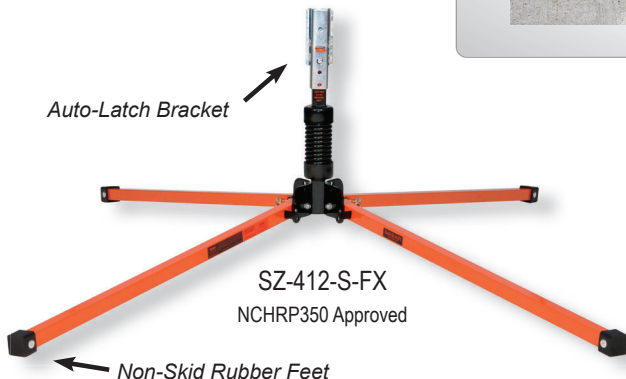

## SafeZone Series SZ-412-S-FX Fixed Leg Single Spring Stand

The **SafeZone Series** SZ-412-S-FX has the same characteristics as the SZ-412-S except the legs are fixed length (FX).

# SafeZone Series SZ-460 & SZ-484 Springless Sign Stands

If you find yourself working in high traffic count work zones, then the SZ-460 is the stand for you! Designed as a high level warning device with 5' bottom height, the SZ-460 can be seen in the most congested of roadways. Its breakaway base and bright orange UV stabilized powder coated legs give the user an added measure of safety in all work areas. Although the SZ-460 is a springless design, its large footprint allows stability of Roll-Up signs in heavy winds without the need for additional ballast. The SZ-460 is available with either Auto-Latch or Universal Bracket.

*The SZ-460 and SZ-484 is perfect for DOT's, Road Pavers, Road Contractors, Signal Crews & Bridge Contractors.*

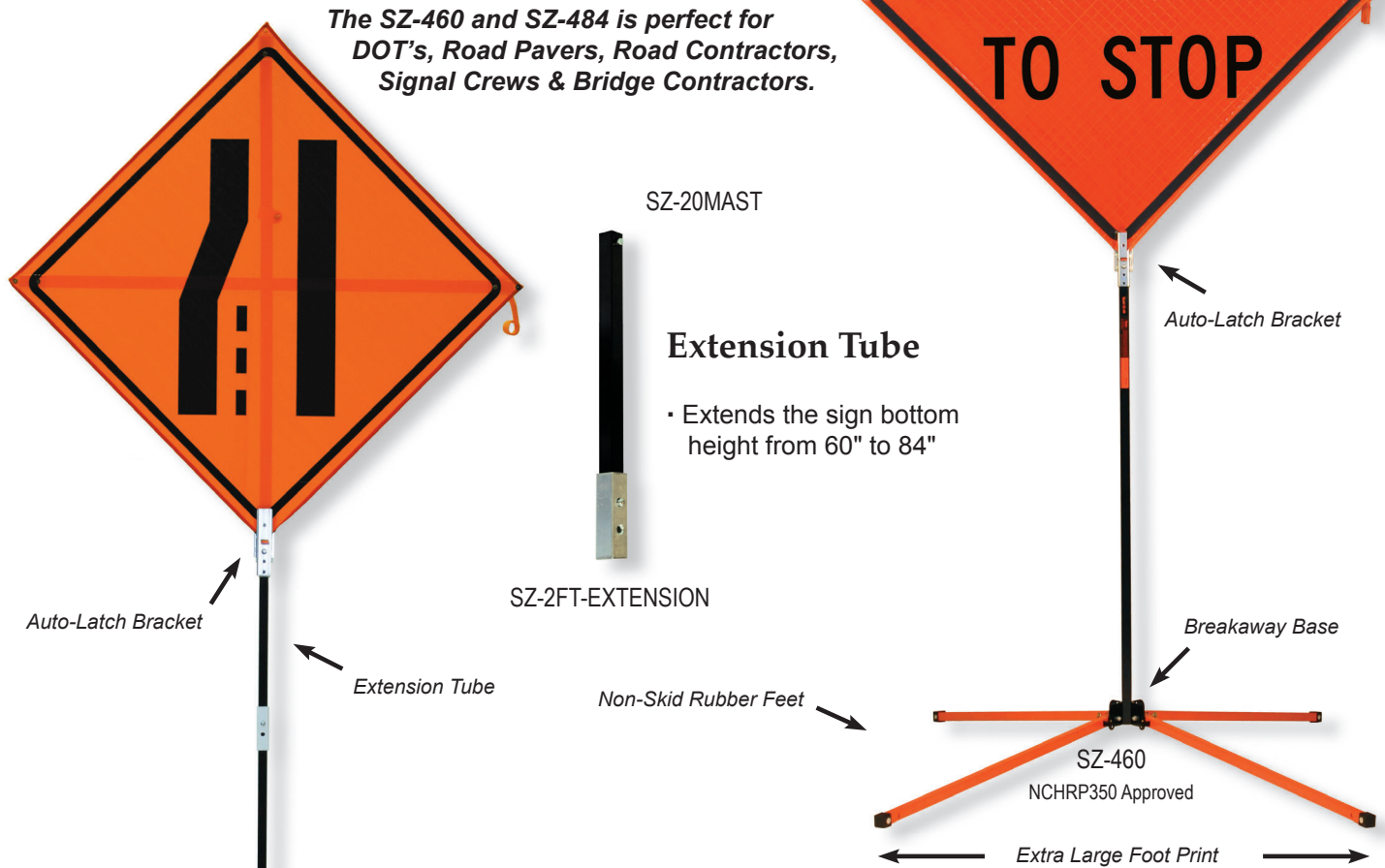

## SafeZone Series SZ-484 Springless Sign Stand

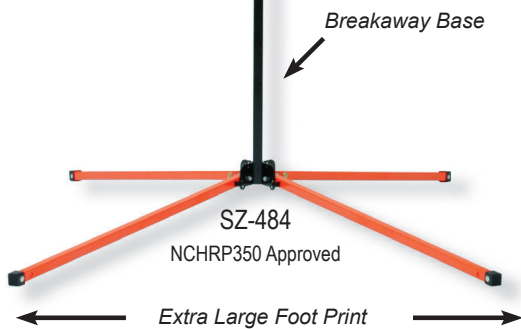

The SZ-484 Springless Sign Stand is designed for extended use as a high-level traffic control device. The sign at a 7' bottom height meets the maximum height requirements for high level warning devices. A must for DOT'S and Road Contractors, the SZ-484 works great with roll-up signs for high visibility and extended use.

# SafeZone Series SZ-460-2S & SZ-484-2S Dual Spring Stand

Bright orange, powder coated legs allow the SZ-460-2S and SZ-484-2S sign stand to be seen from highways to city sidewalks. Like the SZ-460 and SZ-484, the SZ-460-2S has a bottom height of 5' and the SZ-484-2S of 7'. The signs are held above the ground for maximum visibility and height meets the minimum height requirement as set forth in the MANUAL ON UNIFORM TRAFFIC CONTROL DEVICES (MUTCD). With it's heavy-duty dual springs and extended legs design, it can withstand elements and give you years of use without developing memory or sag.



*The SZ-460-2S and SZ-484-2S are perfect for DOT's, Road Pavers, Road Contractors, Signal Crews & Bridge Contractors.*

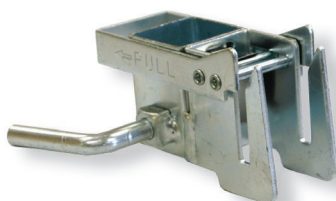
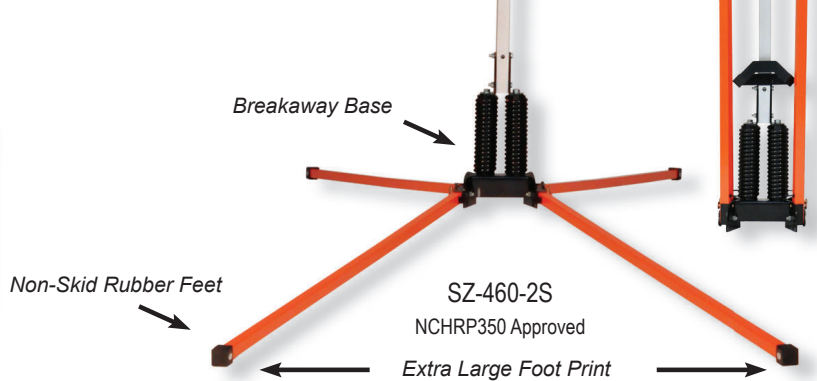

SZ-ROLLUP-BRKT

## Roll-Up Bracket

- Optional Roll-Up bracket for roll-up signs.



# SafeZone Series SZ-312 & SZ-312-E Springless Sign Stand

Designed to withstand moderate winds and light traffic conditions, the SZ-312 is both lightweight and affordable. Like all **SafeZone Series** Sign Stands, the SZ-312 features 3 multi-positional legs with both pull pin & kick release levers. The SZ-312 is the perfect choice for secondary roads, yards and urban areas. (May require additional ballast, such as sand bags.)

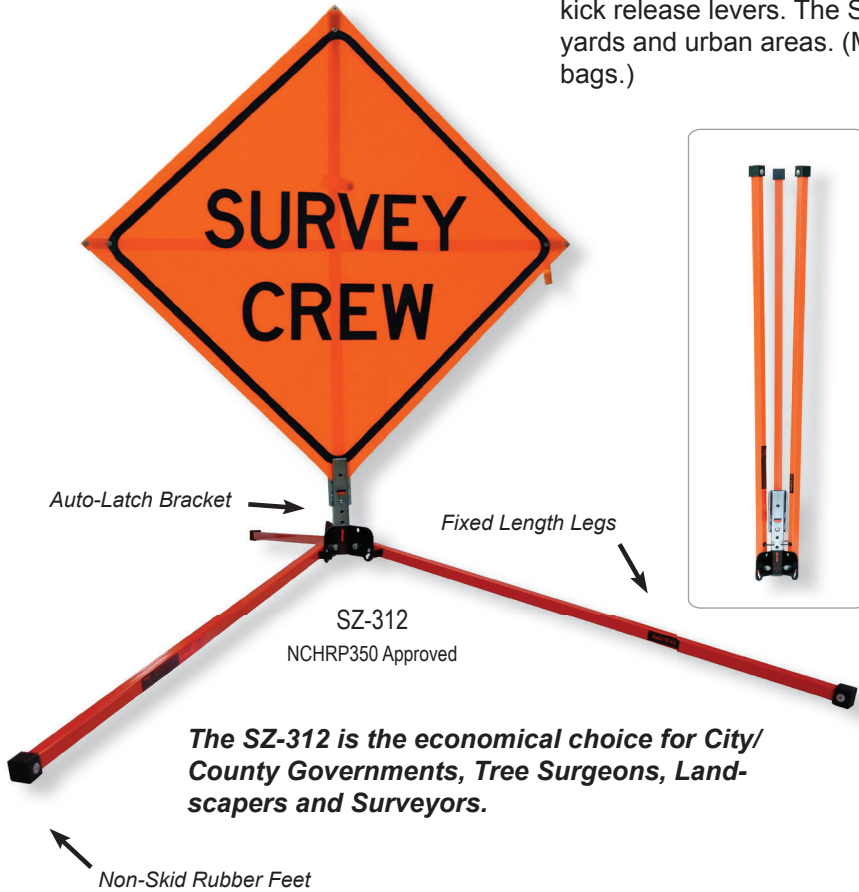

## Crash Designed Breakaway Base

Like all **SafeZone Series** Sign Stands, the SZ-312's new breakaway base is the first of its kind. It has been designed, if impacted, to rotate 90 degrees to the ground, causing no damage to the undercarriage of the impacting vehicle.

## SZ-112 Drive-In Stand

An economical solution with its own built-in driving device.



SZ-112

# SafeZone Series SZ-312-E Springless Sign Stand



The SZ-312-E is the economy version of the SZ-312. It is made for short-term, low speed areas, where a lightweight stand should be used.



# SafeZone Series SZ-412-X (Rigid) Fixed Leg Stand

**NEW  
PRODUCT**



The SZ-412-X is the newest in a long line of proven lightweight, compact, portable rigid sign stands from Bone Safety Signs. The newly designed Rigid Bracket enables the stand to be closed without removing the sign, and our easy-to-use pull pin or kick release lever are used for quick set-up and take down.



**Rigid Bracket**

**NEW  
PRODUCT**



*The SZ-412-X is the right choice for DOT, city or county projects as well as any work within city areas where hills or parked vehicles can impede the visibility of the sign.*

## Roll-Up Bracket for SZ-412-X

The SZ-412-X can also be used with Roll-Up signs by the addition of the Roll-Up Bracket which can raise the sign to a bottom height of 60 inches for maximum visibility in the work zone. Our Roll-Up Bracket ensures the sign stays securely set.



**Roll-Up Bracket.**

# SafeZone Series SZ-RBS Rubber Base System

## SafeZone Series SZ-RBS Rubber Base Sign Stand

It has been said, "You can't be all things to all people." While that is true for most things in life, it is not true for the **SafeZone Series** model SZ-RBS Rubber Base Sign Stand. This unique One Base™ system is quick and easy to set up. The quick release design allows the SZ-RBS to change from a portable stop sign to a vertical panel in seconds. And, best of all, it's manufactured from recycled rubber so it's an environmentally friendly product.

***The SZ-RBS is an economical choice for City/County Governments, Landscapers, Tree Surgeons & Pavement Companies.***



The Quick Release Attachment is removed by pulling the pin and a simple twist of the wrist.



A vertical panel can be changed to a delineator tube in less than 10 seconds with the Quick Release design.

## Quick-Release System is the Key

The Key to the One Base™ system is the unique quick-release mast design. Changing accessories takes less than 10 seconds. To remove the device, simply pull the keeper pin and rotate the mast 15°, then lift and remove. It's as easy as that. The SafeZone One Base™ system can be used as a sign support and can be used with accessories.

It is quick and easy to assemble the devices on site. Bases are stackable for ease in transportation to and from the job site.



## SZ-RBS Sign Stand Features

- 100% Recycled Rubber
- Tough and Lightweight (38 lbs)
- Stackable
- Double Grab handles
- Quick Disconnect Mast Attachment



# SafeZone Series Catapult™ Springless Sign Stand

## SafeZone Series Catapult™ Springless Sign Stand

Unlike conventional molded rubber base stands, the new “Catapult™” tire stand uses old and worn tires for ballast. There is no need to re-formulate used tires for processing into crumb rubber for weighted bases. This eliminates environmental pollution from manufacturing / processing and reduces the cost of tire waste management.

### SPECIFICATIONS

- Compact - 7" x 7" x 11-1/8" Shipping size
- Light weight - 9.9 Lbs
- NCHRP 350 Approved
- Adjustable legs for use in 15" – 21" Tires
- Mast folds for easy storage
- Versatile design for varying accessories

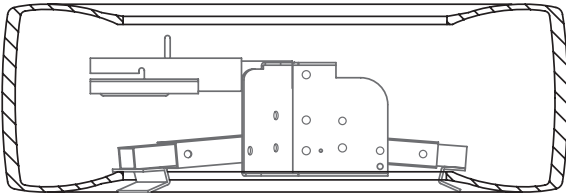

Once the **Catapult™** is adjusted and installed in your tire, it never has to be removed.

*“Our country is creating around 310 million waste/ scrap tires that have to be recycled on a yearly basis.”*

“Waste/Scrap Tire Recycling” – A Growing Industry

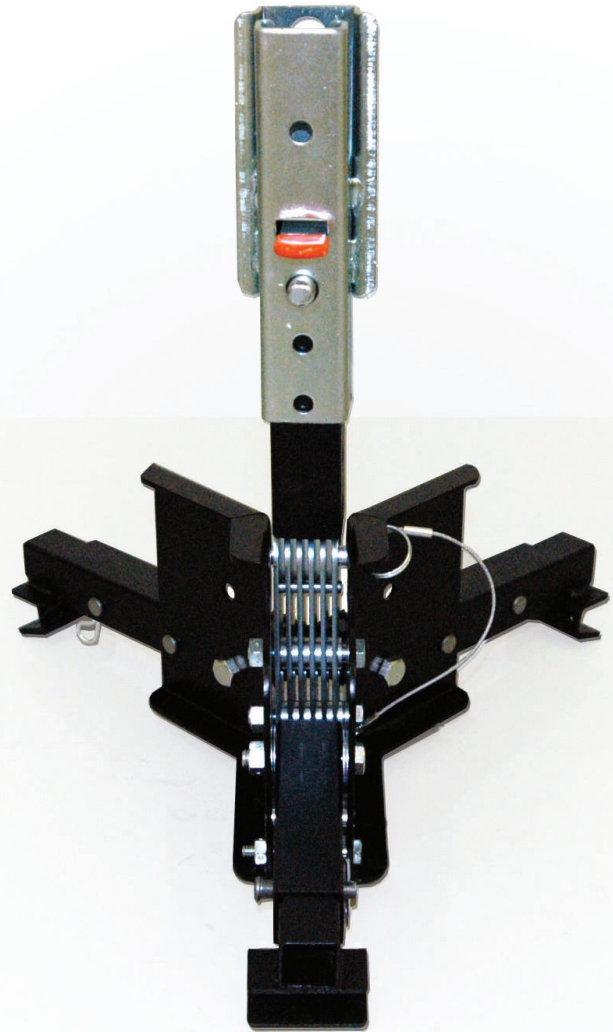

**Get noticed and drive the business to your door.**

Create custom 36"x 36" signs in reflective or mesh materials. Place it in an attractive, light weight, durable and inexpensive Catapult™ sign stand.

Change the signs in seconds with no extra hardware. Once the sign is installed, it will stay securely locked in place.





# SafeZone Series Traffic Control Accessories

## Stop-N-Slow Paddles

Our Stop-N-Slow sign faces are made from the same **BONELIGHT** ACM used for our large construction signs or aluminum.

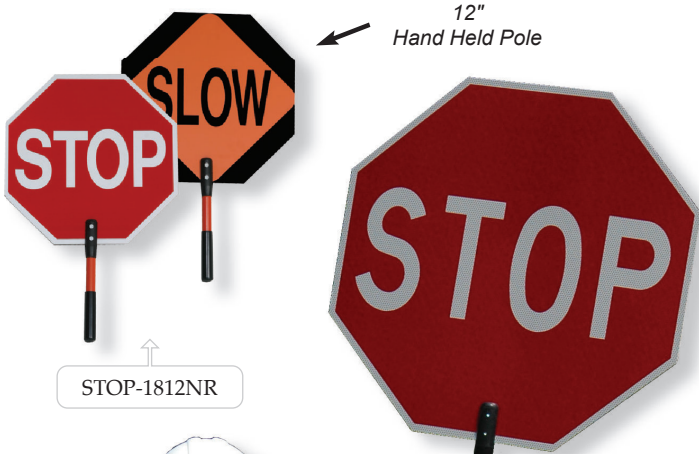

12"  
Hand Held Pole

STOP-1812NR

Bone Tele-Pole



STOP-2484HI

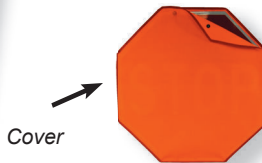

Cover

## Stop-N-Slow Covers

A fluorescent orange cover will add longer life to the paddles.



STOP-2484R

Available in 18" & 24" sizes and various reflective and non-reflective faces.



STOP-2484DGHI

## Bone Tele-Pole

Quick coupling allows the Tele-Pole handle to telescope for increased bottom height and storage.

*Our telepole telescopes to a maximum bottom height of 84".*

Also available is our 12" hand held pole.

## Flag Bracket with folding flags

This rib mounted assembly offers the ability to raise or lower flags as needed.

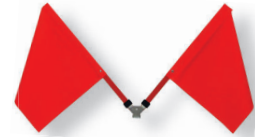

## Flag Bracket

- Attaches to any **SafeZone Series** sign
- Provides option of displaying 2 or 3 flags



## Warning Flags

18" and 24" Wooden Dowel Flags for signaling traffic and mounting to sign stands.



## Traffic Cones

The cones are created from a flow-molded, PVC one-piece design. They are available plain or with reflective collars. All cones meet **NCHRP350** certifications.



# SafeZone Series Traffic Control Accessories

## Bone Wear

The **SafeZone Series** safety vest is constructed of high visibility, UV stabilized fluorescent 100% polyester mesh, meets NFPA 701 flame-retardant test.

Glass bead reflective tape covers the front, back, shoulders and sides of the vest for a full 360° visibility in both day and night time conditions.



Lime/Silver  
Class 3



**Bone Wear can be customized with full color digital printing company names & logos.**



Lime/Silver  
Class 2

Orange/Silver  
Class 2

## Bone Wear Class 2 Economy Mesh Vest

- **SafeZone C2 Series** safety vests are 100% polyester mesh
- ASNI-107-2004 compliant
- Weight is 3 oz per vest
- NFPA 701 flame-retardant
- Velcro or Zipper front closure
- One outside left breast pocket
- 2" wide silver glass bead reflective
- Custom logo's available
- Sizes M-5XL

## Bone Wear Class 3 Mesh Vest

- **SafeZone C3 Series** safety vests are 100% polyester mesh
- ASNI-107-2004 compliant
- Weight is 3 oz per vest
- NFPA 701 flame-retardant
- Velcro or Zipper front closure
- 2" wide silver glass bead reflective
- One outside left breast pocket
- Velcro or zipper front closure
- Custom logo's available
- Sizes M-5XL

\* *Velcro closure are standard and zipper closure are optional.*



Orange/Lime Yellow  
Class 3 Design

## Bone Rain Wear Contrasting Color

Rain wear is available in 49" long coats or two piece suits consisting of a hooded jacket and bib overalls or elastic waist pants. Rain wear is available in Hi-Vis Orange with FI Yellow reflective or Hi-Vis Lime with FI Red Orange reflective.

- 32 Mil Hi-Vis PVC/PU
- 2" Omni-Bright Reflective
- DOT Chevron Packages
- Custom Logos Available
- Class 3 ANSI 107-2004 Designs
- Flame Retardant Fabrics D6413
- Sizes Small thru 5X

# General Terms and Conditions

## Prices and Terms

Pricing and product offerings are subject to change without notice. Please call our toll free number for information regarding current prices and product availability.

**Terms:** Net 30 Days

**F.O.B.** Alpharetta, Georgia

(F.O.B. Destination assigned for orders exceeding \$5000.00 not to include Crumb Rubber Goods or Rigid Signs)

### Late Fees:

A late fee of 1.5% per month may be added to all past due invoices.

## Custom Signs

Bone Safety Signs offers specialized custom signs printed and manufactured to the customers exact specifications in various sizes, colors and materials. Pricing for all custom signs is determined by the quantity and complexity of the order. All custom sign sales are final and non-refundable and may require an artwork charge and/or setup charge. All MUTCD Signs are considered Standard Legends. A sample of popular legends are provided on page 8; for legends not listed, please call your representative.

## Credit Policy

Credit may be issued only with an approved credit application on file. However, we do accept Visa, MasterCard and American Express for customers pending credit approval.

## Manufacturer's Warranty

All Bone Safety Signs' products carry limited warranties against defects in materials and workmanship under normal use and conditions. Bone Safety Signs' obligation under this warranty is limited to replacing any part(s) or material, within 30-days after delivery. Item(s) are to be returned to Bone Safety Signs for examination to determine defect. There are no warranties, expressed or implied, except the warranty against defective part(s) materials and workmanship. However, extended warranties do exist on certain products. Please review the extended warranties in the Price & Specifications Schedule.

## Returned Goods Policy

Products which have been shipped in error or have factory defects may be returned for a credit or full refund. Before returning any products to Bone Safety Signs, you must first request a (Return Materials Authorization Number or RMA#). Please contact our Customer Service Department via our TOLL-FREE number, Email or Fax listed below. All products which have been ordered in error may be subject to a 15% restocking charge and return freight charges. Products returned to Bone Safety Signs without a RMA number will be refused and returned to shipper.

## Customer Service

Toll-Free: (800) 873-2399

Phone: (770) 333-1635 • Fax: (770) 333-1639

Web: [www.bonesafety.com](http://www.bonesafety.com)



# Create Your own Sign

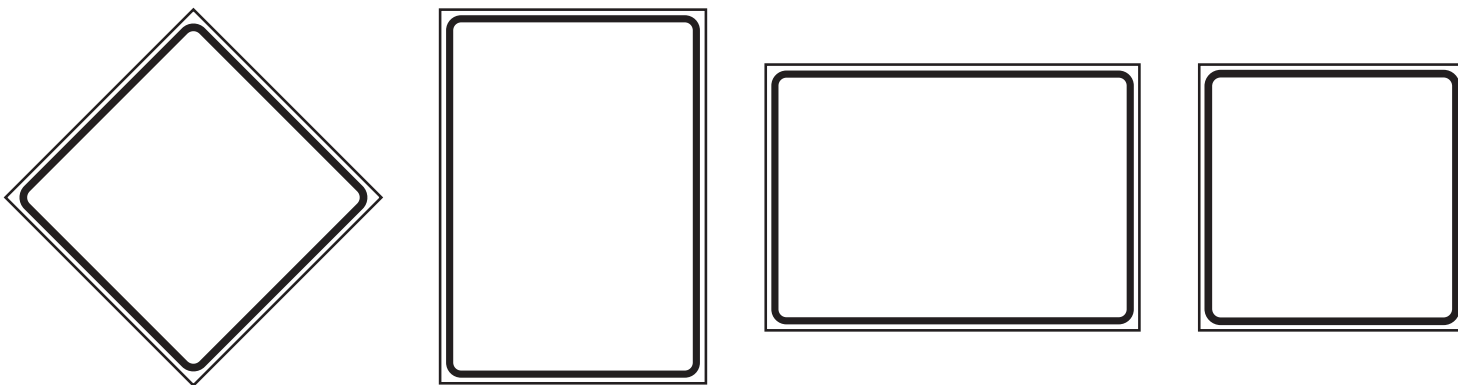

1. Rigid \_\_\_\_\_ or Roll-Up \_\_\_\_\_
2. Width \_\_\_\_\_ Height \_\_\_\_\_
3. Type of Material DG \_\_\_\_\_ HI-INT \_\_\_\_\_ ENG \_\_\_\_\_ MESH \_\_\_\_\_ NRV \_\_\_\_\_ VINYL \_\_\_\_\_

4. Background Color \_\_\_\_\_

5. Message Color \_\_\_\_\_

6. Message Copy Line 1 \_\_\_\_\_  
 Line 2 \_\_\_\_\_  
 Line 3 \_\_\_\_\_  
 Line 4 \_\_\_\_\_

7. Optional Overlays a \_\_\_\_\_  
 b \_\_\_\_\_  
 c \_\_\_\_\_

8. Will you be providing Art Work or Logo \_\_\_\_\_

If Yes, File Name \_\_\_\_\_

### Material Color

	
OR	YL
	
RD	GR
	
PK	BR
	
BL	WH
	
BK	YL-GR

## Office Use

Received Art Work \_\_\_\_\_ Date \_\_\_\_\_  
 Sent Approval Copy \_\_\_\_\_ Date \_\_\_\_\_  
 Received Approval \_\_\_\_\_ Date \_\_\_\_\_



**BONE SAFETY SIGNS**  
 6450 Industrial Way  
 Alpharetta, GA 30004

**Toll Free:** (800) 873-2399  
**Phone:** (770) 333-1635  
**Fax:** (770) 333-1639  
**E-mail:** sales@bonesafety.com  
**Web:** www.bonesafety.com



We accept  
 American Express,  
 Visa and MasterCard

